



Kidde Battery Carbon Monoxide Alarms

7CO



7DCO



EN50291-1 : 2010
EN50291-2 : 2010
License No. KM98848

Contents

1. What is Carbon Monoxide (CO)?
2. Important Safety Information
3. Switching on Your CO Alarm
4. Installation Instructions – Recommended Locations
5. Installation Instructions – Mounting your alarm
6. Using your CO Alarm
Warning Signals, Testing / Re-setting, LCD read-outs (model 7DCO only), Peak Level Display (model 7DCO only)
7. Replacement Batteries / End-of-Life
8. **What To Do If Your Alarm Sounds**
9. Maintenance of your Alarm
10. Troubleshooting
11. Product Specifications
12. Warnings and Important Notices
13. Warranty Information
14. Environmental Protection

Product Features and Specifications

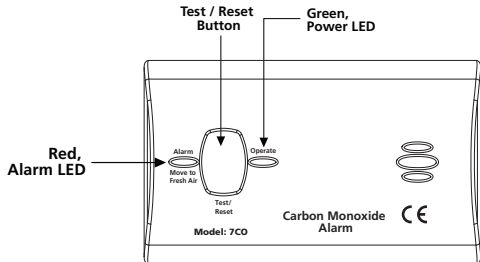

Model 7CO

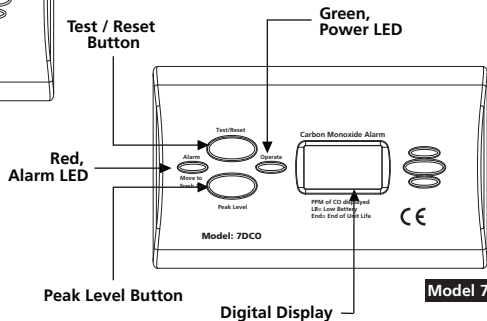

Model 7DCO

1. What is Carbon Monoxide?

Carbon monoxide (CO) is a highly poisonous gas with no taste, colour or smell.

Potential Sources of CO

- Wood-burning stoves
- Gas boilers and fires
- Gas Hobs
- Oil and coal burning appliances
- Portable gas heaters
- Blocked flues and chimneys
- Fumes from integral garages
- Barbecues

This CO alarm is not a substitute for the correct maintenance of your appliances.

Carbon monoxide can be produced from poorly burning appliances or from blocked flues and chimneys.

If your alarm has sounded and you have ventilated the room the CO may have dispersed before help arrives. It is crucial that the source of CO is determined and appropriate maintenance carried out.

Carbon monoxide is a cumulative poison. Longterm exposure to low levels may cause symptoms. This Kidde alarm is time-weighted – the higher the level of CO, the sooner it will alarm.

2. Further information for Caravan and Boat Owners

The following can lead to carbon monoxide being produced:

- Using LPG cooking appliances for space heating
- Leaving LPG appliances on overnight
- Barbecues within the boat cabin or near a caravan door (e.g. under an awning)

To be safe, know the possible sources of CO in your home. Keep fuel burning appliances, chimneys and vents in good working condition. Learn the early symptoms of exposure, and if you suspect CO poisoning, move outside into fresh air and get emergency help. Your first line of defence is an annual inspection and regular maintenance of your appliances. Contact a licensed contractor or call your local utility company for assistance.

2. Alarm levels as defined by EN50291-2010

The table below shows the response times at which your CO alarm will sound;

Parts per Million (PPM) of CO	Time until Alarm
50	60 – 90 minutes
100	10 – 40 minutes
300	Must alarm in less than 3 minutes

CO Advice and Information

The table below shows the effects of different levels of CO poisoning on the body;

Parts per Million (PPM)	Effects on Adults
100	Slight headache, nausea, fatigue (flu-like symptoms)
200	Dizziness and headache within 2 – 3 hours
400	Nausea, frontal headache, drowsiness, confusion and rapid heart rate. Risk to life after over 3 hours of exposure
800	Severe headaches, convulsions, vital organ failures. Death possible within 2 – 3 hours

2. Important Safety Information

If you recognise any of the above symptoms consult your Doctor immediately.

Young children, elderly and pets are more susceptible to the dangers of CO.

Your Kidde alarm is designed to detect CO gas. It is not designed to detect smoke, fire or other gas such natural gas.

This product is intended for use in ordinary family homes. It is not designed to measure compliance with occupational safety and the HSE.

Individuals with certain specific medical conditions may need an alarm that operates below 30ppm. If this applies consult your Doctor.

IMPORTANT: Ensure that all family members are familiar with the symptoms of CO poisoning and how your alarm works.

3. Switching on Your CO Alarm

NOTE: Your CO alarm must be installed by a competent person using the guidance that follows:

1. Remove the batteries from the pack and insert them into the battery compartment. Make sure that you fit the batteries correctly to the polarity markings (+ or -) shown within the battery compartment. If correctly installed, the alarm will give a short beep.
2. To test the alarm, press the test button. The alarm will beep once followed by 4 loud pulses, then a brief pause and then 4 more pulses, ending with a single beep.
3. If you have a digital read-out alarm (model 7DCO) the LCD screen will show “---” and then “888” before settling at “0”
4. Check that the green LED flashes at 30 second intervals to show that the alarm has power. This is easiest to see in a dark area, or with lights switched off.

4. Installation Instructions – Recommended Locations

Recommended Locations	Not Recommended
Place the alarm at least 2 metres from fuel burning appliances, and not more than 4 metres away	Do not place closer than 2 metres from fuel burning appliances
Away from draughts, such as doors and windows	Do not wall-mount close to obstructions (e.g. behind curtains, shelving or furniture)
Within hearing distance of bedrooms* If heating appliance is in the bedroom place the alarm at sleeping height	Do not fit in dusty, dirty or greasy areas (e.g. garages or workshops)
If wall-mounting, install at eye-level (approx 1.5m), and at least 30cm from adjoining walls or ceiling	Do not wall-mount within 30cm of the ceiling as this is a “dead air” space
If free-standing, the unit should be placed no more than 1 metre from the ground (to avoid permanent damage in case accidentally knocked)	Avoid humid (bathrooms), cold (< 4°C) or hot (>40°C) areas and away from sinks

*It is recommended that at least one Kidde carbon monoxide alarm is installed on each level of the home.

5. Installation Instructions – Mounting

THIS ALARM MUST BE INSTALLED BY A COMPETENT PERSON AND IS TO BE INSTALLED ACCORDING TO THESE INSTRUCTIONS

Wall-mounting

1. Drill two holes in a wall 7cm (2 3/8") apart (you may wish to use the back-plate for guidance)
2. Insert the two rawl-plugs, that are supplied, into the holes
3. Insert the two screws as supplied into the holes ensuring enough of the screw sticks out of the wall (approx. 3mm)
4. Hook the alarm over the screws

Free-standing

1. No more than 1 metre from the floor (to minimise this risk of the alarm being permanently damaged should it be knocked to the floor from a greater height)
2. Make sure the alarm is in the upright position and not lying flat on the surface

5. Installation Instructions for Caravans and Boats

As well as being recommended for use in homes, this alarm is approved for use in caravans, motor homes and boats.

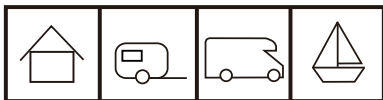

In addition to following CoGDEM (www.cogdem.org.uk) and NCC guidelines;

- Do not install directly above a source of heat or steam.
- Avoid locating close to vehicle and exhaust fumes as these can damage the alarm sensor
In addition to the instructions for boats;
- Avoid locating near engine exhaust gases in the accommodation space
- Avoid running the engine when moored alongside objects such as a wharf, a wall or another boat
- Avoid running your engine when docked in a crowded marina as vehicle and exhaust fumes can damage the alarm sensor. For further information visit www.boatsafetyscheme.com

6. Using Your Alarm (non-digital version, 7CO)

Recognising Alarm Signals and Warnings

Feature	What this means	Required Action
Green LED flashes every 30 seconds	Normal operation	None
The alarm chirps every 60 seconds and the red LED flashes	Low batteries	Replace batteries as soon as possible
Alarm chirps twice every 30 seconds and the red LED flashes twice	End of life of the alarm	Replace the alarm
Alarm chirps every 30 seconds and red LED flashes every 30 seconds	Fault	Replace the alarm
Red LED on and constant tone	Malfunction	Replace the alarm
Loud continuous alarm with the red LED	Dangerous levels of CO have been detected	Follow emergency procedures (see Page16)

6. Using Your Alarm (non-digital version, 7CO)

Testing

Test your alarm each week by pressing the test button. The alarm will beep once followed by 4 loud pulses, then a brief pause and then 4 more pulses, ending with a single beep. While in full alarm, the red LED will flash for 10 seconds.







This confirms that the alarm is powered up and working.

Re-setting the Alarm

If the alarm sounds, the test / reset button will silence the alarm unless it is still detecting dangerous levels of CO. The green light will then flash every 30 seconds to indicate that the alarm has power.

6. Using Your Alarm (for Digital unit only, 7DCO)

Additional features for the CO alarm with the digital display screen, model 5DCO;

Digital Screen	LED	Sound emitted	What this means	Required action
	Green flash every 30 seconds	None	Normal operation. (LCD will not show levels < 30ppm)	None
	Red LED flashes	Full alarm	Dangerous levels of CO has been detected	Follow emergency procedures (see Page 16)
	Red LED flashes	1 beep, then 2 sets of 4 beeps, followed by 1 beep	Successful test or reset sequence in operation	None - this is part of the standard test or reset procedure
	Red LED flashes every 60 seconds	Chirp every 60 seconds	Low batteries (Lb)	Change batteries
	Red LED flashes	Chirp every 30 seconds	Fault	Replace the alarm
	Red LED on	Constant tone	Malfunction	Replace the alarm
	Red LED flashes twice	Chirps twice every 30 seconds	End of Life	Replace the alarm

6. Using Your Alarm (for Digital unit only) – Cont'd

Peak Level Display

Press peak level button to display the most recent CO reading between 11 – 999ppm.

This feature is useful to help you to know what levels of CO may have been detected in your absence so corrective action can be taken (such as servicing your boiler).

NOTE: The peak level memory is cleared to zero if the test and peak level buttons are pressed at the same time, or by removal of the batteries.

CO levels up to 30ppm can occur under normal non-dangerous conditions. Such conditions could include nearby heavy traffic, starting a vehicle in an attached garage, starting a fire or a nearby charcoal barbecue.

7. Replacement of Batteries / End-of-life

Low Batteries

Type of Alarm	LCD	LCD	Sound Emitted
Non-Digital	N/A	Green + Red flashes every 30 seconds	Chirp every 30 seconds
Digital LCD Screen	Lb	Green + Red flashes every 30 seconds	Chirp every 30 seconds

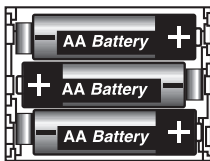

Slide alarm from back-plate.

Insert 3 x replacement 'AA' batteries

(noting polarity – see sketch)

Replace back-plate and test the alarm

Recommended Batteries.
Duracell MN1500, MX1500
Gold Peak 15A
Golden Power GLR6A
Energizer E91

Under normal operating conditions, the batteries will last a minimum of one year. These batteries can be purchased from your local retailer.

End-of-life - This alarm will chirp every 30 seconds with a red LED flash after at least 10 years operation to let you know it has reached its end of life. A replacement needs to be purchased.

8. What to do if Your Alarm Sounds!

Carbon Monoxide Alarm Procedure

 **WARNING! Activation of the alarm indicates the presence of Carbon Monoxide (CO) which can kill you.**

If alarm sounds (4 loud audible pulses followed by a pause for 5 seconds):

- 1) Immediately move to fresh air – outdoors or by an open door/window. Do a head count to check that all persons are accounted for. Do not re-enter the premises nor move away from the open door/window until the emergency services responders have arrived, the premises have been aired out, and your alarm remains in its normal condition.
- 2) Call Gas Emergency Services: 0800 111 999, or your local Gas Safe Registered Engineer:

PHONE NUMBER:

Never restart the source of the CO problem until it has been corrected. Never ignore the sound of the alarm! If the alarm is sounding, pressing the test/reset button will terminate the alarm. If the CO condition that caused the alert in the first place continues, the alarm will reactivate. If the unit alarms again within six minutes, it is sensing high levels of CO which can quickly become a dangerous situation.

9. Maintenance of Your Alarm





To keep your alarm in good working order:

- **Test every week**
- **Vacuum regularly to remove dust**
- **Keep away from solvents or detergents**
- **Avoid spraying air-freshener, hair-spray near the alarm**
- **Do not paint the alarm. If decorating or using adhesives close to the alarm, remove it temporarily**

The following substances can affect the sensor and cause false alarms:

Methane, Propane, Iso-butane, Iso-propanol, Ethylene, Benzene, Toluene, Ethyl acetate, Hydrogen Sulphide, Hydrogen, Sulphur Dioxide, alcohol based products, paints, thinners, solvents, adhesives, hair-sprays, aftershaves or perfumes and some cleaning agents.





10. Troubleshooting

Symptom	LCD Screen Display (model 7DCO-UK only)	Problem	Action Required
Single chirp every 60 seconds plus flashing red LED.		Low batteries	Change the batteries
Single chirp every 30 seconds plus flashing red LED		Alarm fault	Replace alarm (contact Kidde if still in warranty)
Red LED on and constant tone		Alarm malfunction	Replace alarm (contact Kidde if still in warranty)
Two chirps plus red LED flashes twice		End of Life of the alarm	Replace the alarm

11. Product Specifications

Power	3 x AA batteries (as supplied)
Sensor	Electrochemical CO Sensor
Accuracy	Depending on the ambient condition (temperature, humidity) and the condition of the sensor, the alarm readings may vary. The digital readings tolerances are: Ambient: 27°C +/- 12°C (80°F +/- 10°F), atmospheric pressure +/- 10%, 40% +/- 3% relative humidity
Temperature Range	Operating range: 0°C to 40°C
Humidity	up to 90% relative humidity (RH)
Alarm Sound	At Least 85dB (A) at 1 metre @ 3.4 +/- 0.5 KHz pulsing alarm
Size and weight	Weight: 160g Dimensions: 118mm x 70mm x 40mm

12. Warnings and Important Notices

-  **WARNING:** THIS CARBON MONOXIDE ALARM IS NOT A SUBSTITUTE FOR INSTALLING AND MAINTAINING AN APPROPRIATE NUMBER OF SMOKE ALARMS IN YOUR HOME. THIS ALARM WILL NOT SENSE SMOKE, FIRE, OR ANY POISONOUS GAS OTHER THAN CARBON MONOXIDE. FOR THIS REASON YOU MUST INSTALL SMOKE ALARMS TO PROVIDE EARLY WARNING OF FIRE AND TO PROTECT YOU AND YOUR FAMILY FROM FIRE AND ITS RELATED HAZARDS.
-  **WARNING:** THIS PRODUCT IS INTENDED FOR USE IN ORDINARY INDOOR RESIDENTIAL AREAS. IT IS NOT DESIGNED TO MEASURE COMPLIANCE WITH COMMERCIAL AND INDUSTRIAL STANDARDS. THIS ALARM IS NOT SUITABLE FOR INSTALLATION IN HAZARDOUS LOCATIONS . INDIVIDUALS WITH MEDICAL PROBLEMS MAY CONSIDER USING WARNING DEVICES WHICH PROVIDE AUDIBLE AND VISUAL SIGNALS FOR CARBON MONOXIDE CONCENTRATIONS UNDER 30 PPM.
- IMPORTANT:** THIS CARBON MONOXIDE ALARM IS DESIGNED TO DETECT CARBON MONOXIDE FROM ANY SOURCE OF COMBUSTION INCLUDING IMPROPER OR MALFUNCTIONING APPLIANCES. THE INSTALLATION OF THIS DEVICE SHOULD NOT BE USED AS A SUBSTITUTE FOR PROPER INSTALLATION, USE AND MAINTENANCE OF FUEL BURNING APPLIANCES INCLUDING APPROPRIATE VENTILATION AND EXHAUST SYSTEMS
-  **WARNING:** THIS ALARM WILL NOT WORK WITHOUT POWER. THIS ALARM REQUIRES A CONTINUOUS SUPPLY OF POWER.
-  **WARNING:** THIS UNIT IS NOT A SMOKE ALARM. IT WILL NOT SENSE SMOKE . FOR EARLY WARNING OF FIRE YOU MUST INSTALL SMOKE ALARMS.
- IMPORTANT:** IF ANY FAULT SIGNALS OCCUR, CONTACT THE MANUFACTURER OR SUPPLIER AND DO NOT CONTINUE USING THE ALARM

13. Warranty

TEN YEAR LIMITED WARRANTY

WARRANTY COVERAGE: THE MANUFACTURER WARRANTS TO THE ORIGINAL CONSUMER PURCHASER, THAT THIS PRODUCT WILL BE FREE OF DEFECTS IN MATERIAL AND WORKMANSHIP FOR A PERIOD OF TEN (10) YEARS FROM DATE OF PURCHASE. THE MANUFACTURER'S LIABILITY HEREUNDER IS LIMITED TO REPLACEMENT OF THE PRODUCT. REPAIR OF THE PRODUCT OR REPLACEMENT OF THE PRODUCT WITH REPAIRED PRODUCT AT THE DISCRETION OF THE MANUFACTURER. THIS WARRANTY IS VOID IF THE PRODUCT HAS BEEN DAMAGED BY ACCIDENT, UNREASONABLE USE, NEGLIGENCE, TAMPERING OR OTHER CAUSES NOT ARISING FROM DEFECTS IN MATERIAL OR WORKMANSHIP. THIS WARRANTY EXTENDS TO THE ORIGINAL CONSUMER PURCHASER OF THE PRODUCT ONLY.

Warranty Disclaimers: Any implied warranties arising out of this sale, including but not limited to the implied warranties of description, merchantability and fitness for a particular purpose, are limited in duration to the above warranty period. In no event shall the Manufacturer be liable for loss of use of this product or for any indirect, special, incidental or consequential damages, or costs, or expenses incurred by the consumer or any other user of this product, whether due to a breach of contract, negligence, strict liability in tort or otherwise. The Manufacturer shall have no liability for any personal injury, property damage or any special, incidental, contingent or consequential damage of any kind resulting from gas leakage, fire or explosion. This warranty does not affect your statutory rights.

Warranty Performance: During the above warranty period, your product will be replaced with a comparable product if the defective product is returned, postage prepaid, to KIDDE Safety Europe Ltd, Mathisen Way, Colnbrook, Slough SL3 0HB. Telephone 01753 685148, together with proof of purchase date. Please include a note describing the problem when you return the unit. The replacement product will be in warranty for the remainder of the original warranty period or for six months, whichever is longer. Other than the cost of postage, no charge will be made for replacement of the defective product. Important: Do not open unit. Opening unit will void warranty.

Your Carbon Monoxide Alarm is not a substitute for property, disability, life or other insurance of any kind. Appropriate insurance coverage is your responsibility. Consult your insurance agent. Kidde makes no warranty, express or implied, written or oral, including that of merchantability or fitness for any particular purpose, with respect of the batteries.

For Warranty Service: In many cases the quickest way to exchange your CO alarm is to return it to the original place of purchase. If you have questions, call the KIDDE customer service department on 01753 685148

14. Environmental Protection

Waste electrical products should not be disposed of with household waste. Please recycle where facilities exist. Check with Local Authority or retailer for recycling advice



Useful Contact Information

Kidde Helpline	(UK) 0800 917 0722 / (Ireland) 1800 818 601
Emergency No.s	Gas Emergency Services 0800 111 999
	HETAS (Solid Fuel Emergency) 0845 634 5626
	Oftec (oil) 0845 658 5080

CoGDEN CO Advice Line 0800 1694 457

Kidde Website www.kiddesafetyeurope.co.uk

Manufacturer Address
Kidde Safety Europe Limited
Mathisen Way
Colnbrook
Berkshire
SL3 0HB

P/N: 2530-7202-02